

6-GFM(G)-200Ah

Gel Battery Specification

Features

- Maintenance free
- Safety and no leakage
- Excellent recharge and discharge performance
- Low self-discharge rate
- Adapt to high or low temperature
- Good deep discharge performance
- Longer cycle life



Specification

Rated Voltage	12V
Numbers of cells	6 Cells
Capacity	200Ah@10hr-rate to 1.80V per cell @25°C
Weight	62.4kg
Internal Resistance	Approx. 3.5mΩ
Terminal	F1 / F2
Max. Discharge Current	3000A(5s)
Short Circuit Current	10000A
Max. Charging Current	50A
Reference Capacity	C10 200.0AH C3 144.7AH C1 110.1AH
Design Life	10~15 years
Float Charging Voltage	13.6 V~13.8 V @ 25°C Temperature Compensation: -20mV/°C/Cell
Cycle Use Voltage	14.4 V~14.9 V @ 25°C Temperature Compensation: -30mV/°C/Cell
Operating Temperature Range	Discharge: -20°C~60°C Charge: 0°C~50°C Storage: -20°C~60°C
Normal Operating Temperature Range	25°C±5°C
Self Discharge	Less than 3% at 25°C per month
Container Material	A.B.S. UL94-HB, UL94-V0 Optional.

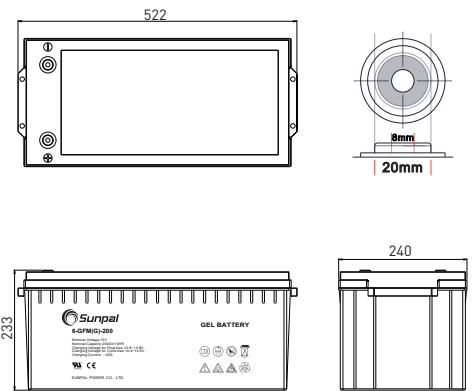

Length	522±2mm (20.6 inches)
Width	240±1mm (9.4 inches)
Height	219±1mm (8.6 inches)
Total Height	223±1mm (8.8 inches)

Constant Current Discharge Characteristics: A(25°C)

F.V/Time	5min	10min	15min	20min	30min	45min	1h	3h	5h	10h	20h
1.80V/cell	212.97	163.08	122.75	102.86	63.96	48.24	33.85	29.23	23.30	20.00	10.99
1.75V/cell	239.34	179.34	132.75	110.11	67.80	50.99	35.16	30.22	24.07	20.44	11.21
1.70V/cell	257.80	192.09	140.99	116.48	71.87	53.08	36.26	31.32	24.73	20.88	11.32
1.65V/cell	268.35	199.56	145.93	120.88	73.74	54.84	37.03	31.76	25.16	21.21	11.43
1.60V/cell	290.77	213.63	156.81	128.35	76.70	57.03	38.13	32.53	25.60	21.54	11.65

Constant Power Discharge Characteristics: WPC(25°C)

F.V/Time	5min	10min	15min	20min	30min	45min	1h	3h	5h	10h	20h
1.80V/cell	402.31	311.32	236.37	199.23	124.51	94.29	66.59	57.58	46.15	39.89	21.87
1.75V/cell	447.14	339.23	253.63	212.20	131.43	99.34	68.90	59.45	47.58	40.66	22.31
1.70V/cell	476.37	360.22	267.36	223.19	138.68	103.19	70.88	61.43	48.90	41.54	22.53
1.65V/cell	490.33	370.33	274.95	230.33	141.54	105.93	72.20	62.31	49.56	41.98	22.75
1.60V/cell	525.38	392.64	293.19	243.19	146.59	109.67	74.18	63.52	50.33	42.75	23.08

6-GFM(G)-200Ah

Gel Battery Specification

Charge Characteristics for Float Use @ 25°C/77°F

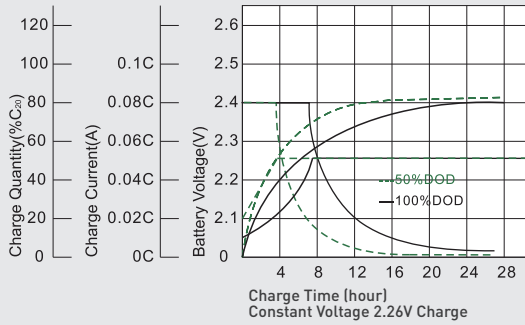

Discharge Characteristics at Various Rates @ 25°C/77°F

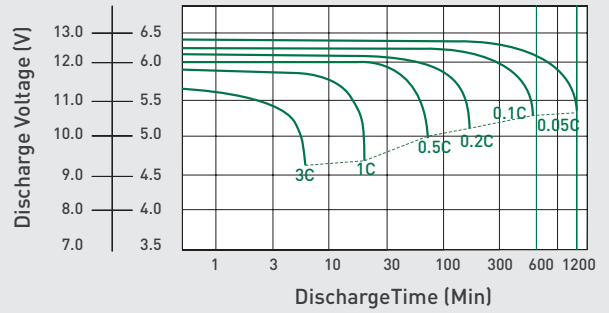

Cycle Life in Relation to Depth of Discharge

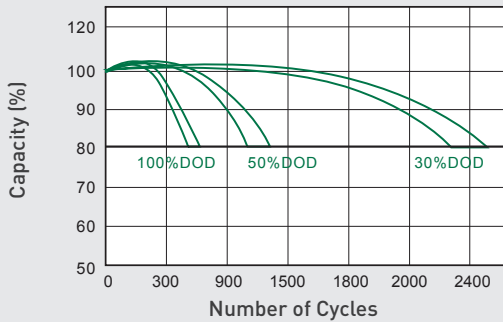

Float Service Life

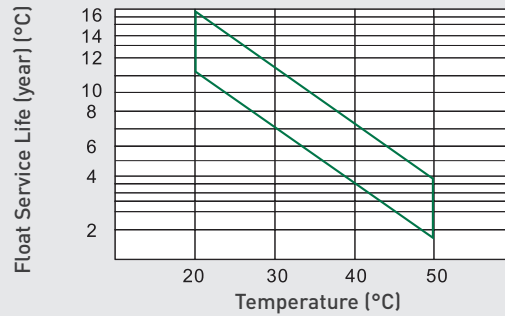

Temperature and Valid Capacity

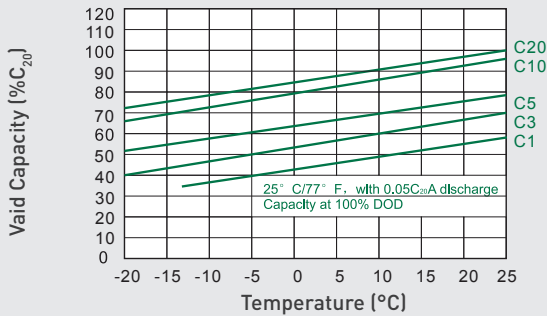

Self Discharge Characteristics

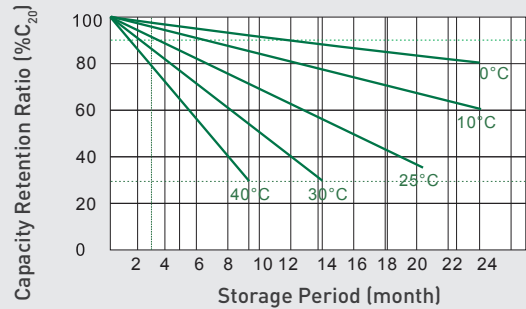

Capacity and Open Circuit Voltage

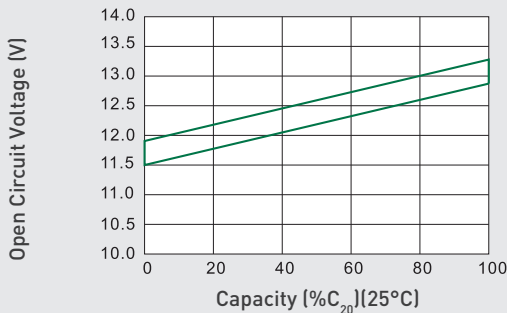

Relationship between Charging Voltage and Temperature

